

东莞市欧思科光电科技有限公司

DONGGUAN OPSCO OPTOELECTRONICS CO., LTD

Factory : Lianxing industrial park, xiajie village, Qishi Town, Dongguan City. guangdong province, China

Dongguan Tel: (769)82632725

Dongguan Fax: (769)82632735

SK6812RGBW-BW

ACKNOWLEDGMENT CHIP-ON-TOP SMD TYPE LED

Document No.: SPC/ SK6812RGBW-BW

Model No.: SK6812RGBW-BW

Description: 5.4x5.0x1.6mm Top SMD Type 4-chips 0.3 Watt Power
RGB Color And Blue White Color LED

Material: InGaN or AllnGaP Chip Inside

Rev. No.: 01

Date: 2019-01-21

Color	Color Bin Table	Base Order Codes Luminous Intensity @13 mA (lm)			Notes
		Group	MIN.	MAX.	
R/G/B/W	BW-B:7000-8300K BW-C:6000-7000K	R	1.0	2.0	A: 50% Power Angle is 120° B:The proportion of different color areas: BW-A(8300-10000K):10% BW-B(7000-8300K):60% BW-C(6000-7000K):20% BW-D(5500-6000K):10%
		G	3.0	5.0	
		B	1.0	2.0	
		W	5.0	7.0	

CUSTOMER APPROVAL		CEETUS APPROVAL	
AFFIRM		Prepared by	易明芬
		Checked by	周凯
		Approved by	朱更生

东莞市欧思科光电科技有限公司

DONGGUAN OPSCO OPTOELECTRONICS CO., LTD

Factory : Lianxing industrial park, xiajie village, Qishi Town, Dongguan City. guangdong province, China

Dongguan Tel: (769)82632725

Dongguan Fax: (769)82632735

SK6812RGBX-XX



5.4x5.0x1.6mm Top SMD Type 0.25 Watt Power
targeted light source Intelligent control LED(MSL:5a)



Change History

Date	Rev. No.	Changes/Reason of changes	Signature
2015-05-08	01	Initial Document	KEVIN ZHU
2015-08-20	02	Modified model and parameter	KEVIN ZHU
2017-08-17	03	Correct specifications	KEVIN ZHU
2018-01-02	04	Error correction of lamp bead notch direction	KEVIN ZHU
2018-04-30	05	Corrected color zone map	KEVIN ZHU
2018-11-20	06	Modified timetable range	KEVIN ZHU
2019-01-15	07	Revision of Specification Format	KEVIN ZHU

东莞市欧思科光电科技有限公司

DONGGUAN OPSCO OPTOELECTRONICS CO., LTD

Factory : Lianxing industrial park, xiajie village, Qishi Town, Dongguan City. guangdong province, China

Dongguan Tel: (769)82632725

Dongguan Fax: (769)82632735

CONTENTS

1、Product overview.....	Three
2、Main Application Field.....	Three
3、Description.....	Three
4、Mechanical Dimensions.....	Three
5、PIN configuration.....	Four
6、Recommended dimensions for PCB products.....	Four
7、General description of product naming.....	Four
8、Electrical parameters.....	Five
9、Electrical/Optical Characteristics.....	Five
10、The IC electrical parameters.....	Five
11、Switching characteristics.....	Six
12、The data transmission time	Six
13、Timing waveform.....	Seven
14、The method of data transmission.....	Seven
15、The data structure of 24bit.....	Eight
16、The typical application circuit.....	Eight
17、Hue Bin Specification for Yellow/Red/Green/Blue.....	Nine
18、White Color Temperature Ranks.....	Ten~Thirteen
19、Standard LED Performance Graph.....	Fourteen
20、Packaging Standard.....	Fifteen
21、Reliability Test.....	Sixteen
Appendix 1、TOP SMD LED Application Notes.....	Seventeen~Twenty-two

东莞市欧思科光电科技有限公司

DONGGUAN OPSCO OPTOELECTRONICS CO., LTD

Factory : Lianxing industrial park, xiajie village, Qishi Town, Dongguan City, guangdong province, China

Dongguan Tel: (769)82632725

Dongguan Fax: (769)82632735

1. Product Overview :

SK6812RGBW is a smart LED control circuit and light emitting circuit in one controlled LED source, which has the shape of a 5050 LED chip. Each lighting element is a pixel, and the intensities of the pixels are contained within the intelligent digital interface input. The output is driven by patented PWM technology, which effectively guarantees high consistency of the color of the pixels. The control circuit consists of a signal shaping amplification circuit, a built-in constant current circuit, and a high precision RC oscillator.

The data protocol being used is unipolar RZ communication mode. The 32-bit data is transmitted from the controller to DIN of the first element, and if it is accepted it is extracted pixel to pixel. After an internal data latch, the remaining data is passed through the internal amplification circuit and sent out on the DO port to the remaining pixels. The pixel is reset after the end of DIN. Using automatic shaping forwarding technology makes the number of cascaded pixels without signal transmission only limited by signal transmission speed.

The LED has a low driving voltage (which allows for environmental protection and energy saving), high brightness, scattering angle, good consistency, low power, and long life. The control circuit is integrated in the LED above.

2. Main Application Field:

- Full color LED string light, LED full color module, LED super hard and soft lights, LED guardrail tube, LED appearance / scene lighting
- LED point light, LED pixel screen, LED shaped screen, a variety of electronic products, electrical equipment etc..

3. Description:

- Top SMD internal integrated high quality external control line serial cascade constant current IC;
- control circuit and the chip in SMD 5050 components, to form a complete control of pixel, color mixing uniformity and consistency;
- built-in data shaping circuit, a pixel signal is received after wave shaping and output waveform distortion will not guarantee a line;
- The built-in power on reset and reset circuit, the power does not work;
- gray level adjusting circuit (256 level gray scale adjustable);
- red drive special treatment, color balance;
- line data transmission;
- plastic forward strengthening technology, the transmission distance between two points over 10M;
- Using a typical data transmission frequency of 800 Kbps, when the refresh rate of 30 frames per sec

4. Mechanical Dimensions:

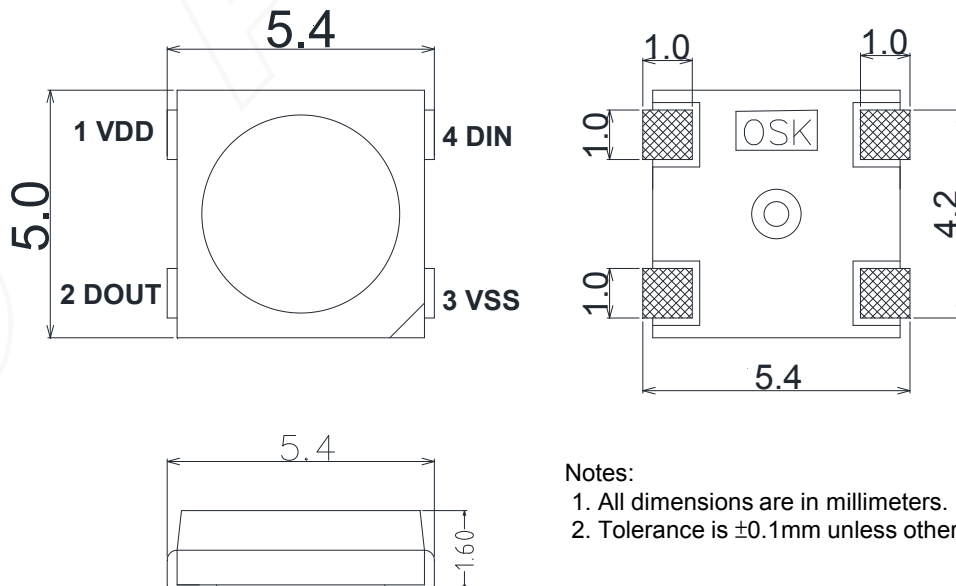

东莞市欧思科光电科技有限公司

DONGGUAN OPSCO OPTOELECTRONICS CO., LTD

Factory : Lianxing industrial park, xiajie village, Qishi Town, Dongguan City. guangdong province, China

Dongguan Tel: (769)82632725

Dongguan Fax: (769)82632735

5. PIN configuration

NO.	Symbol	Function description
1	VDD	Power supply LED
2	DOUT	Control data signal output
3	VSS	Ground
4	DIN	Control data signal input

6. Recommended dimensions for PCB products

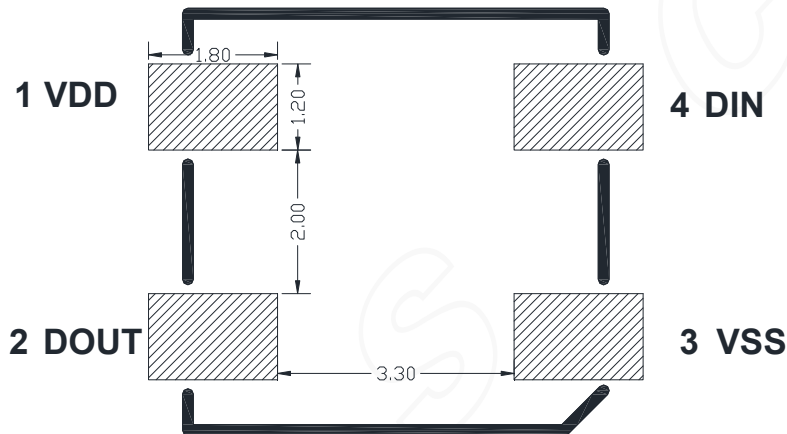

7. General description of product naming.

SK 6812RGBX-XX

①

②

③

①	②	③
Series	IC series and current code	Color zone
<p>The default is to integrate the RGB and X chip with the IC</p> <p>X: W White Color A 585-595nm</p>	<p>Refers to the 68 series IC 12MA current version</p>	<p>XX: BW Blue White 5500-10000K NW Natural White 3800-4500K WS Warm Sunlight 2700-3200K GW GOLD White 2400-2700K</p>

东莞市欧思科光电科技有限公司

DONGGUAN OPSCO OPTOELECTRONICS CO., LTD

Factory : Lianxing industrial park, xiajie village, Qishi Town, Dongguan City. guangdong province, China

Dongguan Tel: (769)82632725

Dongguan Fax: (769)82632735

8. Electrical Parameters (Ta=25°C, VSS=0V) :

Parameter	Symbol	Range	Unit
Power supply voltage	VDD	+3.7~+5.5	V
Logic input voltage	V _{IN}	-0.5~VDD+0.5	V
Working temperature	T _{opt}	-40~+85	°C
Storage temperature	T _{stg}	-50~+150	°C
ESD pressure(HBM)	V _{ESD}	4K	V
ESD pressure(DM)	V _{ESD}	200	V

9. Electrical/Optical Characteristics:

Color	SK6812RGBX-XX		
	Dominate avelength(nm)	Luminance(mcd)	luminous flux(lm)
Red	620-630	300-500	0.5-1.5
Green	515-530	1000-1500	2.0-3.0
Blue	460-475	200-400	0.5-1.0
Yellow	580-590	300-500	0.5-1.5
WHITE	2400-10000K	3300-5000	5.5-6.5

10. The IC electrical parameters (unless otherwise specified, TA=-20 ~ +70 °C, VDD=4.5 ~ 5.5V, VSS=0V):

Parmeter	Symbol	Min	Typical	Max	Unit	Test conditions
The chip supply voltage	VDD	---	5.2	---	V	---
The signal input flip threshold	V _{IH}	0.7*VDD	---	---	V	VDD=5.0V
	V _{IL}	---	---	0.3*VDD	V	
The frequency of PWM	FPWM	---	1.2	---	KHZ	---
Static power consumption	IDD	---	1	---	mA	---

东莞市欧思科光电科技有限公司

DONGGUAN OPSCO OPTOELECTRONICS CO., LTD

Factory : Lianxing industrial park, xiajie village, Qishi Town, Dongguan City. guangdong province, China

Dongguan Tel: (769)82632725

Dongguan Fax: (769)82632735

11. Switching characteristics(Ta=25 °C):

Parameter	Symbol	Min	Typical	Max	Unit	Test conditions
The speed of data transmission	fDIN	---	800	---	KHZ	The duty ratio of 67% (data 1)
DOOUT transmission delay	TPLH	---	---	500	ns	DIN→DOOUT
	TPHL	---	---	500	ns	
IOOUT Rise/Drop Time	Tr	---	100	---	ns	VDS=1.5 IOOUT=9~18mA
	Tf	---	100	---	ns	

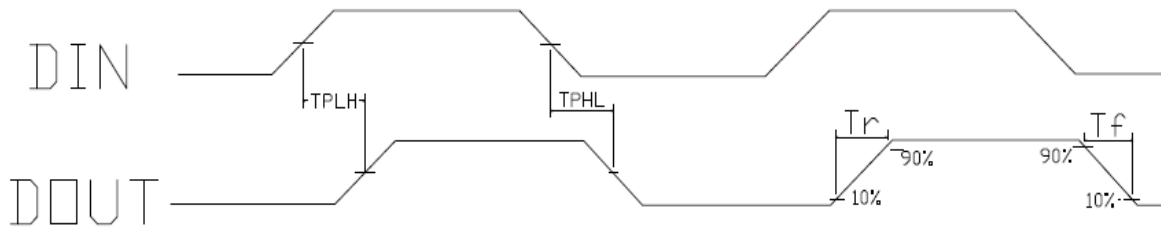

12. The data transmission time :

Name	Min.	Standard value	Max.	Unit
T	1.20	--	--	μs
T0H	0.2	0.35	0.4	μs
T0L	0.8	--	--	μs
T1H	0.58	0.64	1.0	μs
T1L	0.2	--	--	μs
Trst	>80	--	--	μs

1. The protocol uses a unipolar zeroing code. Each symbol must have a low level. Each symbol in this protocol starts with a high level. The high time width determines the "0" or "1" code. .

2. When writing programs, the minimum symbol period is 1.2 μs.

3. The high time of "0" code and "1" code should be in accordance with the stipulated range in the above table. The low time requirement of "0" code and "1" code is less than 20 μs.

东莞市欧思科光电科技有限公司

DONGGUAN OPSCO OPTOELECTRONICS CO., LTD

Factory : Lianxing industrial park, xiajie village, Qishi Town, Dongguan City. guangdong province, China

Dongguan Tel: (769)82632725

Dongguan Fax: (769)82632735

13. Timing waveform:

Input code:

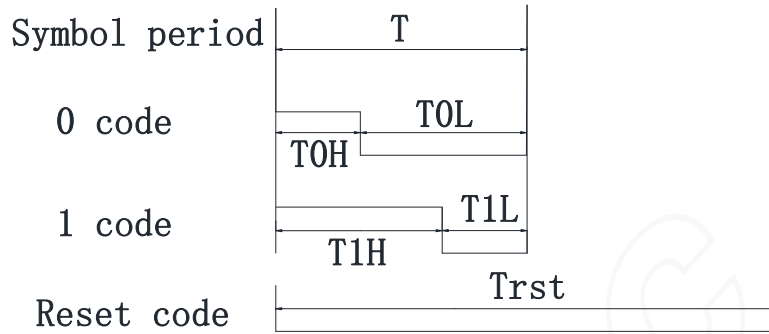

Connection mode:

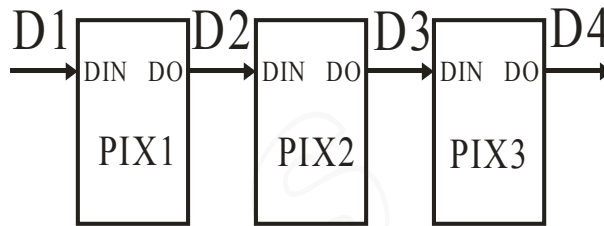

14. The method of data transmission:

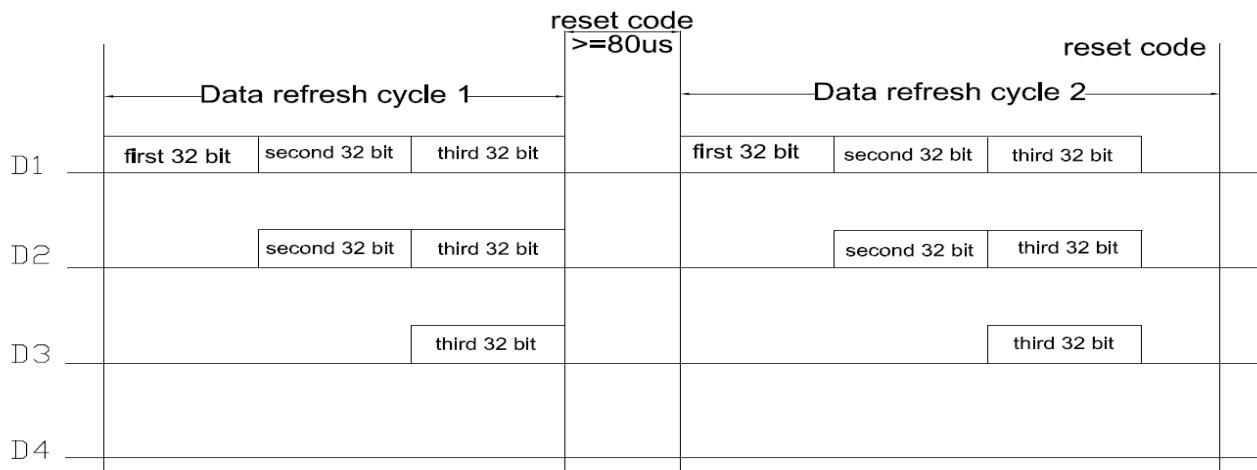

Note: the D1 sends data for MCU, D2, D3, D4 for data forwarding automatic shaping cascade circuit.

东莞市欧思科光电科技有限公司

DONGGUAN OPSCO OPTOELECTRONICS CO., LTD

Factory : Lianxing industrial park, xiajie village, Qishi Town, Dongguan City. guangdong province, China

Dongguan Tel: (769)82632725

Dongguan Fax: (769)82632735

15. The data structure of 32bit:

G7	G6	G5	G4	G3	G2	G1	G0	R7	R6	R5	R4
R3	R2	R1	R0	B7	B6	B5	B4	B3	B2	B1	B0
W7	W6	W5	W4	W3	W2	W1	W0				

Note: high starting, in order to send data (G7 - G6 - W0)

16. The typical application circuit:

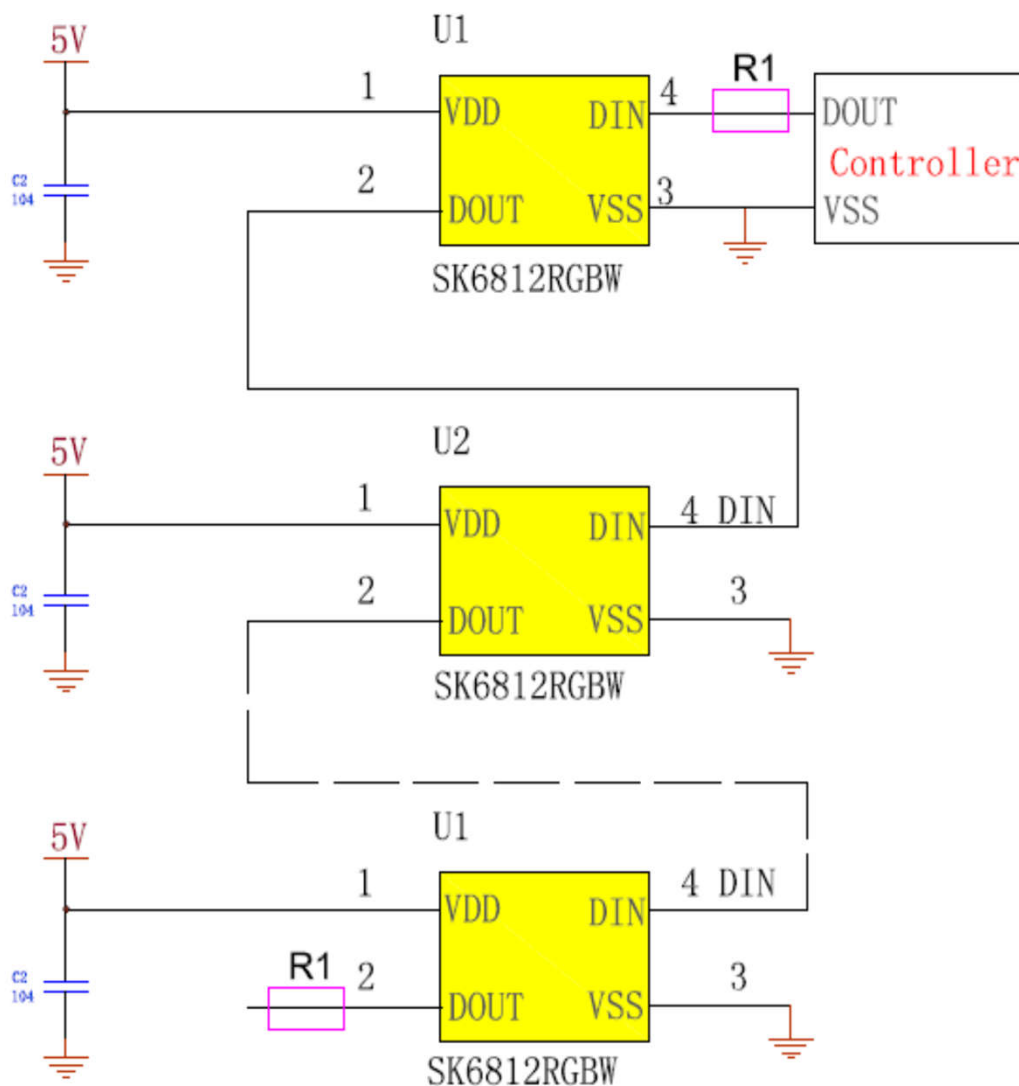

In the practical application circuit, the signal input and output pins of the IC signal input and output pins should be connected to the signal input and output terminals. In addition, in order to make the IC chip is more stable, even the capacitance between beads is essential back;

Application: used for soft lamp strip or hard light, lamp beads transmission distance is short, suggested in signal in time the clock line input and output end of each connected in series protection resistors, $R1=R0$ of about 500 ohms.

Application: for module or general special-shaped products, lamp beads transmission distance is long, because of different wire and transmission distance, in the signal in time clock at both ends of the line on grounding protection resistance will be slightly different; to the actual use of fixed;

东莞市欧思科光电科技有限公司

DONGGUAN OPSCO OPTOELECTRONICS CO., LTD

Factory : Lianxing industrial park, xiajie village, Qishi Town, Dongguan City. guangdong province, China

Dongguan Tel: (769)82632725

Dongguan Fax: (769)82632735

17. Hue Bin Specification for Yellow 、 Red 、 Green 、 Blue

Name	Code	λ d MIN (nm)	λ d MAX (nm)
YELLOW	YL1	585	590
	YL2	590	595
RED	HR1	620	625
	HR2	625	630
BLUE	BL5	460	465
	BL6	465	470
GREEN	PG2	515	520
	PG3	520	525
	PG4	525	530

东莞市欧思科光电科技有限公司

DONGGUAN OPSCO OPTOELECTRONICS CO., LTD

Factory : Lianxing industrial park, xiajie village, Qishi Town, Dongguan City. guangdong province, China

Dongguan Tel: (769)82632725

Dongguan Fax: (769)82632735

18. White Color Temperature Ranks & CIE Color Rank (Refer to CIE 1931 chromaticity diagram)

CIE chromaticity coordinates (ANSI Cool White)

Name	X1	Y1	X2	Y2	X3	Y3	X4	Y4
BW-A	0.2928	0.2822	0.2802	0.2895	0.2885	0.3007	0.3011	0.2934
BW-B	0.3011	0.2934	0.2885	0.3007	0.302	0.3189	0.3147	0.3116
BW-C	0.3147	0.3116	0.302	0.3189	0.3186	0.3412	0.3313	0.3339
BW-D	0.3313	0.3339	0.3186	0.3412	0.3326	0.36	0.3449	0.3522

ANSI Blue White Color bin structures

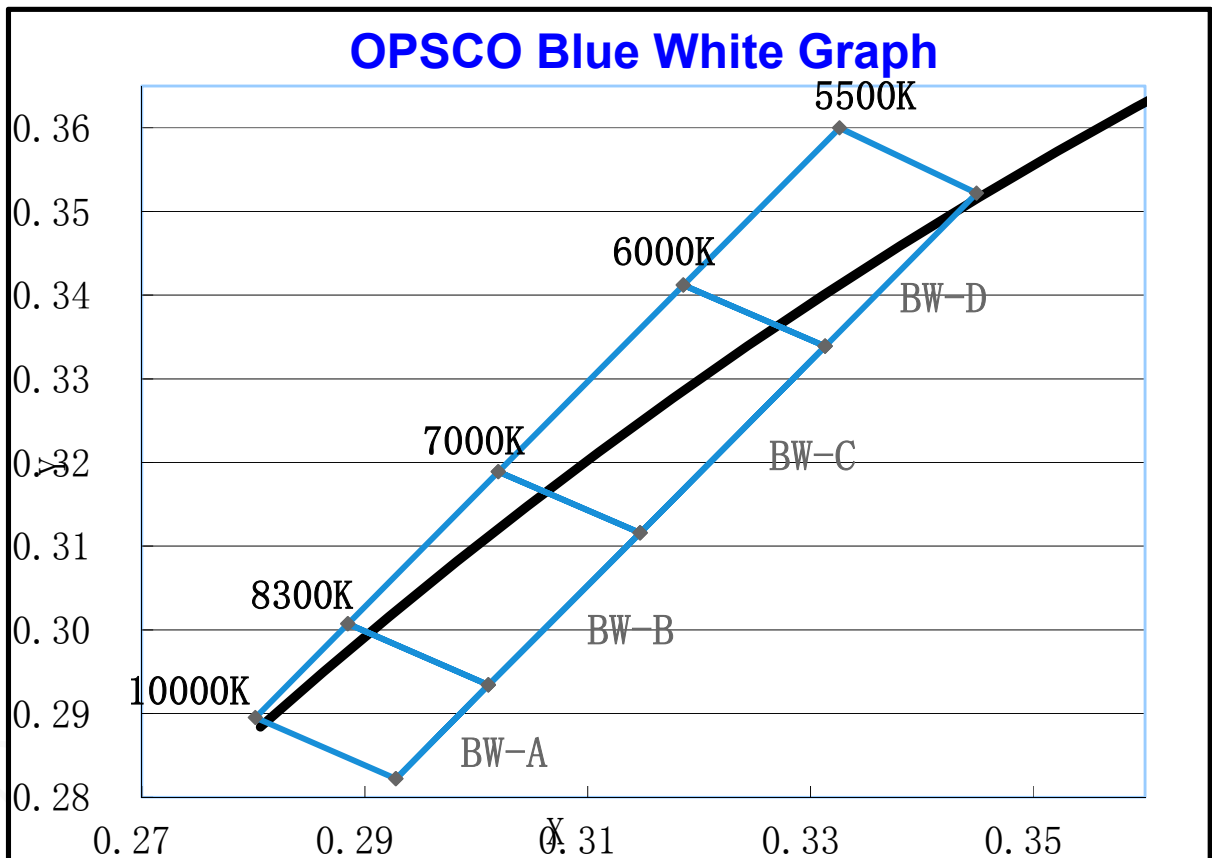

东莞市欧思科光电科技有限公司

DONGGUAN OPSCO OPTOELECTRONICS CO., LTD

Factory : Lianxing industrial park, xiajie village, Qishi Town, Dongguan City. guangdong province, China

Dongguan Tel: (769)82632725

Dongguan Fax: (769)82632735

CIE chromaticity coordinates (ANSI Natural white)

名称	X1	Y1	X2	Y2	X3	Y3	X4	Y4
NO-A	0.358	0.3445	0.3461	0.3521	0.3531	0.36	0.3651	0.3524
NA-A	0.3651	0.3524	0.3531	0.36	0.3602	0.3679	0.3722	0.3603
NB-A	0.3722	0.3603	0.3602	0.3679	0.3659	0.3743	0.3779	0.3667
NC-A	0.3779	0.3667	0.3659	0.3743	0.3716	0.3807	0.3836	0.373
ND-A	0.3836	0.373	0.3716	0.3807	0.3773	0.3871	0.3893	0.3794
NE-A	0.3893	0.3794	0.3773	0.3871	0.3844	0.3949	0.3963	0.3873

ANSI Natural White Color bin structures

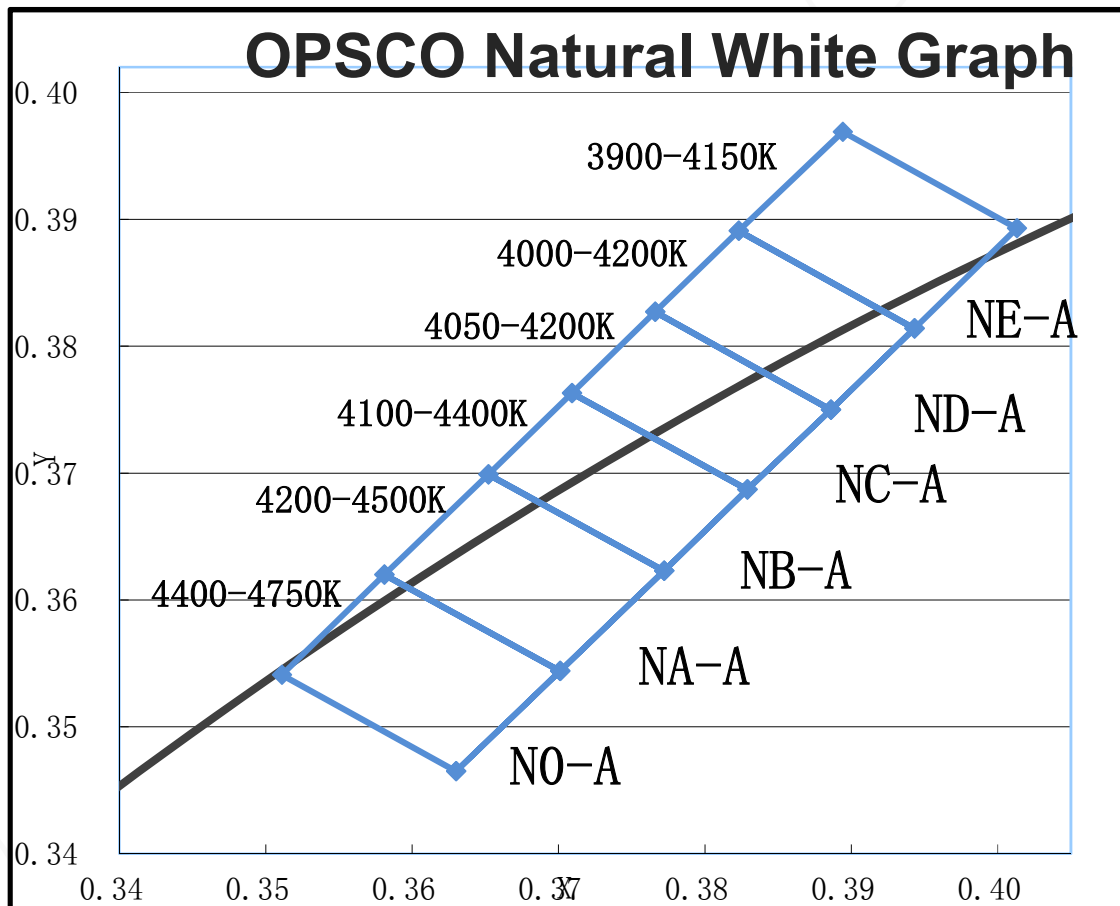

东莞市欧思科光电科技有限公司

DONGGUAN OPSCO OPTOELECTRONICS CO., LTD

Factory : Lianxing industrial park, xiajie village, Qishi Town, Dongguan City. guangdong province, China

Dongguan Tel: (769)82632725

Dongguan Fax: (769)82632735

CIE chromaticity coordinates (ANSI Warm White)

名称	X1	Y1	X2	Y2	X3	Y3	X4	Y4
K1-A	0.4344	0.4032	0.4221	0.3984	0.4147	0.3814	0.426	0.3853
K2-A	0.443	0.4212	0.4299	0.4165	0.4221	0.3984	0.4344	0.4032
K3-A	0.4562	0.426	0.443	0.4212	0.4344	0.4032	0.4465	0.4071
K4-A	0.4465	0.4071	0.4344	0.4032	0.426	0.3853	0.4373	0.3893
L1-A	0.4586	0.4103	0.4465	0.4071	0.4373	0.3893	0.4483	0.3918
L2-A	0.4687	0.4289	0.4562	0.426	0.4465	0.4071	0.4586	0.4103

ANSI Warm White Color bin structures

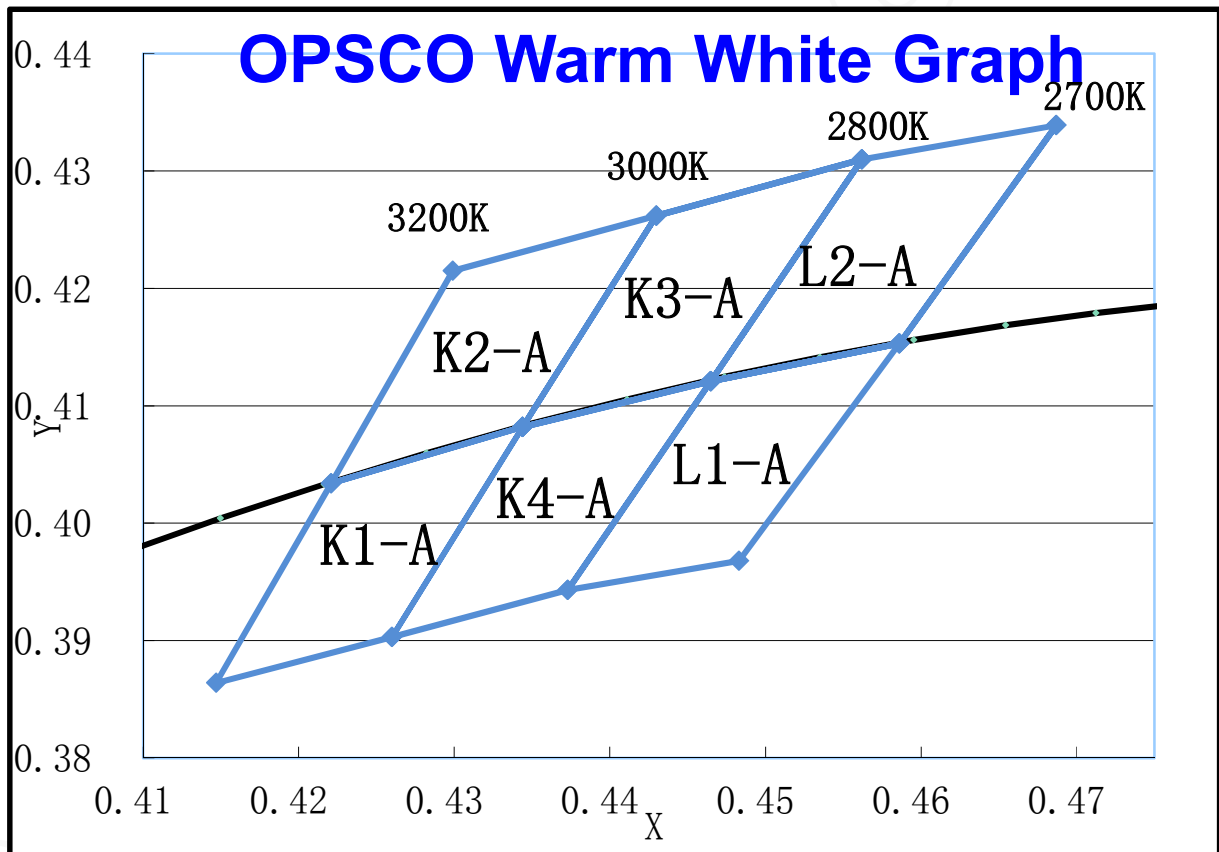

东莞市欧思科光电科技有限公司

DONGGUAN OPSCO OPTOELECTRONICS CO., LTD

Factory : Lianxing industrial park, xiajie village, Qishi Town, Dongguan City. guangdong province, China

Dongguan Tel: (769)82632725

Dongguan Fax: (769)82632735

CIE chromaticity coordinates (ANSI Warm Lighting)

CA	X1	Y1	X2	Y2	X3	Y3	X4	Y4
GA	0.459741	0.3982	0.4548	0.4045	0.4613	0.4096	0.4662	0.4033
GB	0.466212	0.4033	0.4613	0.4096	0.4677	0.4147	0.4727	0.4084
GC	0.472682	0.4084	0.4677	0.4147	0.4742	0.4198	0.4792	0.4135
GD	0.479152	0.4135	0.4742	0.4198	0.4807	0.4248	0.4856	0.4185
GE	0.485622	0.4185	0.4807	0.4248	0.4872	0.4299	0.4921	0.4236
GA1	0.462676	0.3945	0.4597	0.3982	0.4662	0.4033	0.4693	0.3994
GB1	0.469255	0.3994	0.4662	0.4033	0.4727	0.4084	0.4758	0.4044
GC1	0.475835	0.4044	0.4727	0.4084	0.4792	0.4135	0.4824	0.4093
GD1	0.482415	0.4093	0.4792	0.4135	0.4856	0.4185	0.489	0.4142
GE1	0.488995	0.4142	0.4856	0.4185	0.4921	0.4236	0.4956	0.4192

ANSI Warm Lighting Color bin structures

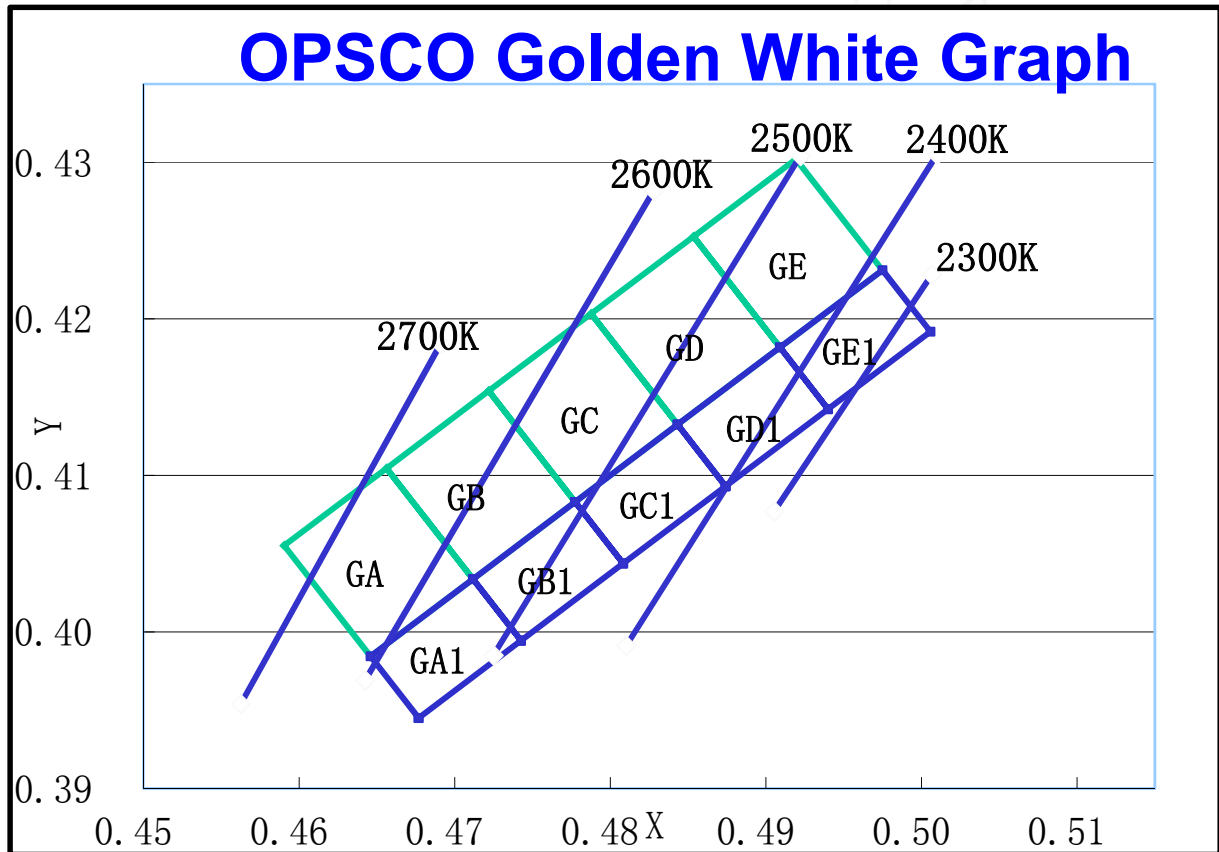

- Color coordinates measurement allowance is ± 0.005
- To order specify color temperature ranks, please contact OPSCO Lighting Holdings LTD. for further information.
- Thermal Pad Temperature @25°C @ 20mA

东莞市欧思科光电科技有限公司

DONGGUAN OPSCO OPTOELECTRONICS CO., LTD

Factory : Lianxing industrial park, xiajie village, Qishi Town, Dongguan City. guangdong province, China

Dongguan Tel: (769)82632725

Dongguan Fax: (769)82632735

19. Standard LED Performance Graph:

Thermal Pad Temperature vs. Relative Light Output

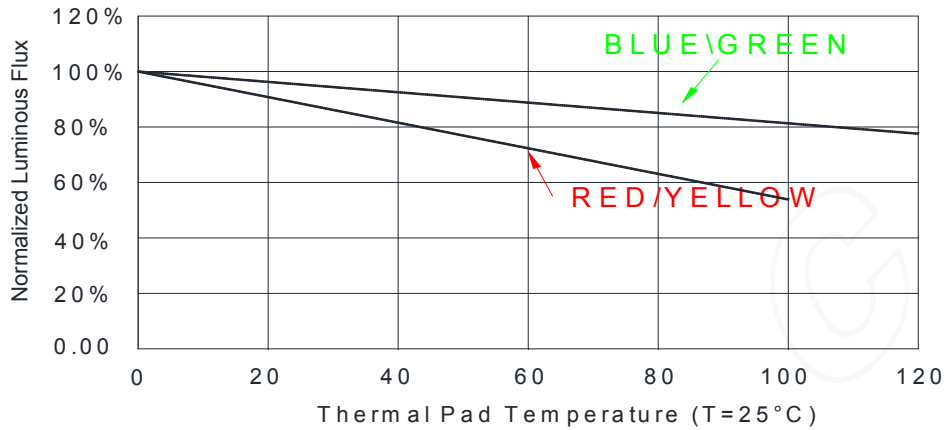

Wavelength Characteristics

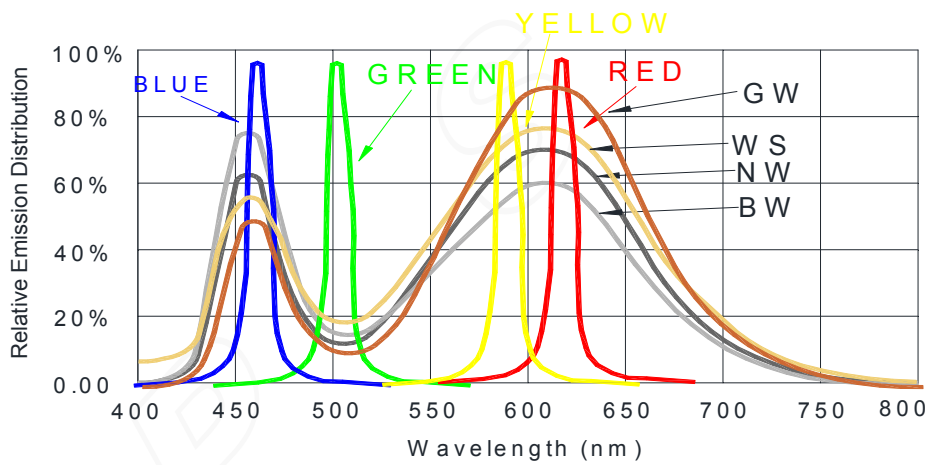

Typical Radiation Pattern 120°

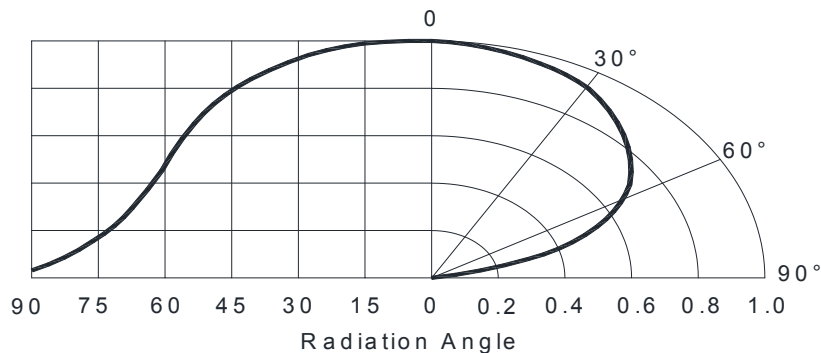

东莞市欧思科光电科技有限公司

DONGGUAN OPSCO OPTOELECTRONICS CO., LTD

Factory : Lianxing industrial park, xiajie village, Qishi Town, Dongguan City. guangdong province, China

Dongguan Tel: (769)82632725

Dongguan Fax: (769)82632735

20. Packaging Standard:

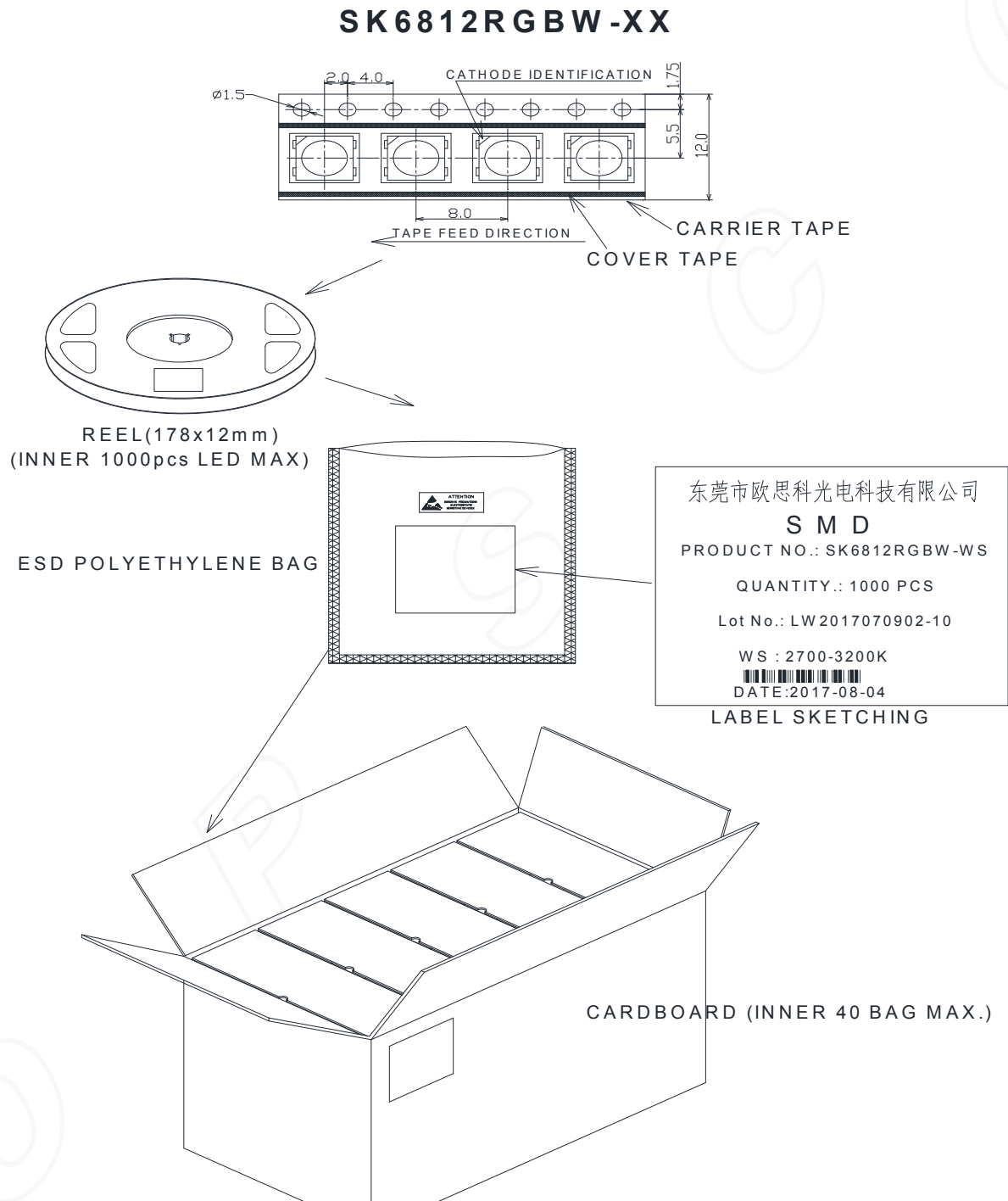

The reel pack is applied in SMD LED. The LEDs are packed in cardboard boxes after packaging in normal or anti-electrostatic bags. cardboard boxes will be used to protect the LEDs from mechanical shocks during transportation. The boxes are not water resistant and therefore must be kept away from water and moisture.

东莞市欧思科光电科技有限公司

DONGGUAN OPSCO OPTOELECTRONICS CO., LTD

Factory : Lianxing industrial park, xiajie village, Qishi Town, Dongguan City. guangdong province, China

Dongguan Tel: (769)82632725

Dongguan Fax: (769)82632735

21. Reliability Test :

NO.	Test item	Test Conditions	Reference	Criterion
1	Thermal Shock	100 ± 5° C ~ -40° C ± 5° C 30min~30min 300 cycles	MIL-STD-202G	0/22
2	High Temperature Storage	Ta= +100° C 1000hrs	JEITA ED-4701 200 201	0/22
3	Low Temperature Storage	Ta= -40° C 1000hrs	JEITA ED-4701 200 202	0/22
4	High Temperature High Humidity Storage	Ta=60° C RH=90% 1000hrs	JEITA ED-4701 100 103	0/22
5	Temperature Cycle	-55° C~25° C~100° C~25° C 30min~5min~30min~5min 100 cycles	JEITA ED-4701 100 105	0/22
6	Resistance to Soldering Heat	Tsld = 260° C, 10sec. 3 times	JEITA ED-4701 300 301	0/22
7	Room temp Life Test	25° C, IF: Typical current , 1000hrs	JESD22-A 108D	0/22

Criteria for Judging the Damage:

Item	Symbol	Test Condition	Limit	
			Min	Max
Luminous Intensity	IV	DC=5V, Typical current	Init. Value*0.7	---
Resistance to Soldering Heat	---	DC=5V, Typical current	No dead lights or obvious damage	

东莞市欧思科光电科技有限公司

DONGGUAN OPSCO OPTOELECTRONICS CO., LTD

Factory : Lianxing industrial park, xiajie village, Qishi Town, Dongguan City. guangdong province, China

Dongguan Tel: (769)82632725

Dongguan Fax: (769)82632735

APPENDIX1.TOP SMD LED Application Notes

1. Features

The Purposes of making OPSCO's customers and users to have a clear understanding on the ways how to use the LED.

2. Description

Generally. The LED can be used the same way as other general purposed semiconductors. When using OPSCO's TOP SMD LED, the following precautions must be taken to protect the LED.

3. Cautions

3.1. Dust & Cleaning

This emitter has a silicone surface, There are many benefits to the silicone surface in terms of optical properties and improved reliability. However, silicone is a softer material and prone to attract dust. While a minimal amount of dust and debris on the LED will not cause significant reduction in illumination, steps should be taken to keep the emitter free of dust.

These include keeping the LEDs in the manufacturer's package prior to assembly and storing assemblies in an enclosed area after installing the emitters.

Surface condition of this device may change when organic solvents such as trichloroethylene or acetone were applied.

Avoid using organic solvent, it is recommended that isopropyl be used as a solvent for cleaning the LEDs. When using other solvents, it should be confirmed beforehand whether the solvents will dissolve the package and the resin or not.

Do not clean the LEDs by the ultrasonic. When it is absolutely necessary, the influence as ultrasonic cleaning on the LEDs depends on factors such as ultrasonic power. Baking time and assembled condition. Before cleaning, a pre-test should be done to confirm whether any damage to the LEDs will occur.

3.2. Shipment and storage

TOP SMD LED is a humidity sensor, the LED packaging in the aluminum bag is to avoid the LED in the transport and storage of moisture absorption, in the bag with a desiccant to absorb the moisture inside the bag. If the LED absorbs water vapor, then in the LED over reflow, in the high temperature state, into which the rapid expansion of gas vaporization and produce a greater internal stress, so that the material crack, layered or damaged bonding wire, Resulting in product failure.

TOP SMD LED with a moisture-proof anti-static aluminum foil bag packaging, handling should avoid the process of squeezing, piercing the case of bags, and do the necessary anti-static protective measures; promise products on the line before the leak or broken, Please stop the use of direct use of the product; , Resulting in product failure;

Such as before the material has been found to prevent moisture-proof aluminum foil bags have been opened, damaged, perforated can be returned to the original re-dehumidification, must not be on-line use;

The humidity level of this product is LEVEL5a.

东莞市欧思科光电科技有限公司

DONGGUAN OPSCO OPTOELECTRONICS CO., LTD

Factory : Lianxing industrial park, xiajie village, Qishi Town, Dongguan City. guangdong province, China

Dongguan Tel: (769)82632725

Dongguan Fax: (769)82632735

Chart 1: Definition of material's MSL prescribed by IPC/JEDECJ-STD-020E

Moisture proof	Workshop lifespan after open the packaging	
	Time	condition
LEVEL1	unlimited	$\leq 30^{\circ}\text{C}/85\% \text{ RH}$
LEVEL2	1 year	$\leq 30^{\circ}\text{C}/60\% \text{ RH}$
LEVEL2a	4 Weeks	$\leq 30^{\circ}\text{C}/60\% \text{ RH}$
LEVEL3	168 Hours	$\leq 30^{\circ}\text{C}/60\% \text{ RH}$
LEVEL4	72 Hours	$\leq 30^{\circ}\text{C}/60\% \text{ RH}$
LEVEL5	48 Hours	$\leq 30^{\circ}\text{C}/60\% \text{ RH}$
LEVEL5a	24 Hours	$\leq 30^{\circ}\text{C}/60\% \text{ RH}$
LEVEL6	Take off and use immediately	$\leq 30^{\circ}\text{C}/60\% \text{ RH}$

3.3. Storage before unsealing

In order to avoid the moisture barrier caused by the reliability of the failure problem, need to do LED products SMT pre-storage and moisture-proof measures;

If the moisture-proof bag is not open, the TOP SMD element will be stored for less than 2 months at $<30^{\circ}\text{C} / 60\% \text{ RH}$; (Note: The label date is the same and the packing is not leaked. Discoloration under the premise of use; for different moisture-proof grade materials or packaging to save the time there is a certain difference, the specific preservation time to the specification book or packaging tips prevail); recommended in the unassembled do not open the moisture before the bag;

3.4. Control after the packing bag is opened

After opening the moisture-proof bag, please read the moisture-proof bag inside the humidity indicator card in the moisture-proof beads into pink to confirm moisture in the moisture bag is too much, according to the color of the ball to determine whether the bag material on-line operation; And the material after opening the package should be strictly controlled in the table 1 as specified by the maximum temperature and humidity and operating time allowed, as long as the material exposed in the environment described in Table 1, the need to accumulate its use in the workshop time. Open the bag and paste the material on the PCB board, should be completed within 0.5H welding work, do not recommend the material attached to the PCB, a long time stay in the workshop does not carry out SMT work; Caused by adverse water within the lead;

3.5. Definition of humidity card

Open the package after the TOP SMD LED bag inside the humidity card color instructions are as follows:

- If the moisture card 10% of the moisture-proof beads into pink, other files for the blue, this situation, LED can be used directly;
- If the humidity card moisture-proof beads 10%, 20% at all become pink, in fact, the file is blue, this situation, the need for low-temperature components dehumidification;
- If the humidity card moisture-proof beads 10%, 20%, 30% more than three are turned pink, in this case, the customer needs to return the material to our company for high humidity dehumidification, re-packaging before use;

东莞市欧思科光电科技有限公司

DONGGUAN OPSCO OPTOELECTRONICS CO., LTD

Factory : Lianxing industrial park, xiajie village, Qishi Town, Dongguan City. guangdong province, China

Dongguan Tel: (769)82632725

Dongguan Fax: (769)82632735

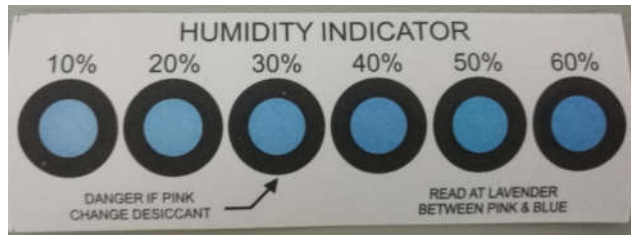

Humidity indicator D0 not change color

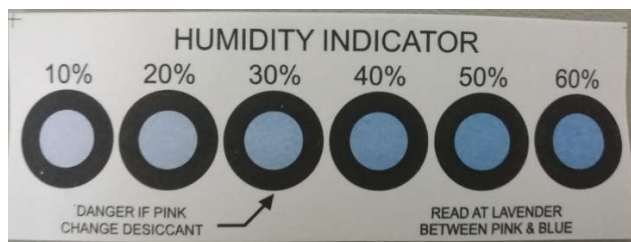

Humidity indicator turns pink in 10% 20%

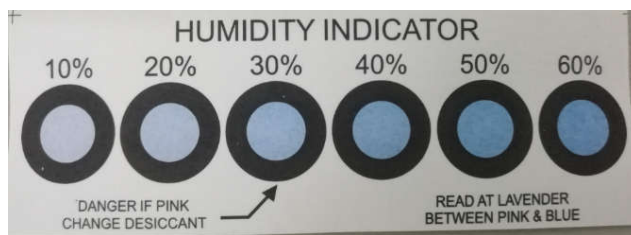

Humidity indicator turns pink in 10% 20% 30%

3.6. Unwanted material moisture-proof storage and moisture-proof control of finished material

If a roll of SMDs is not used at once and the plant temperature and humidity are within the defined conditions (<math> < 30^{\circ}\text{C} / 60\% \text{RH}</math>), the exposure time of the element in the air does not exceed 2H, the remaining material should be carried out together with the desiccant Vacuum sealed, otherwise, the material must be low-wet baking dehumidification; dehumidified material can be re-packaged to re-start the calculation time;

Perform moisture control on SMDs components that have been assembled

- After the components have been assembled to the PCB board no longer need to go through the high temperature process or reflow process, it will not be special treatment;
- Do not need to do the necessary dehumidification work before making the appropriate protection process, bake in $70^{\circ}\text{C} \pm 5^{\circ}\text{C}$ oven baking for less than 12 hours, To remove the product in the detection and aging process exposed to moisture in the air to avoid the product in the protective treatment, the package in the material surface of the moisture will slowly invade the product, will cause product failure;
- For products that require secondary SMT process or high temperature, they should be subjected to the necessary moisture treatment before secondary welding, after exposure to (<math> < 30^{\circ}\text{C} / 60\% \text{RH}</math>), The maximum length of not more than 2H, Connaught second high temperature process separated by a long time, then a welding material must be necessary dehumidification work ($70^{\circ}\text{C} \pm 5^{\circ}\text{C}$ oven baking no less than 12 hours), and then pumping Vacuum storage; or the first product stored in the oven or with a desiccant container, the second high-temperature process before doing dehumidification work ($70^{\circ}\text{C} \pm 5^{\circ}\text{C}$ in the oven baking no less than 12 hours), To ensure that products in the high temperature before the process is not damp;

Low-temperature baking conditions: $70^{\circ}\text{C} \pm 5^{\circ}\text{C}$ baking not less than 12 hours high temperature baking conditions: $130^{\circ}\text{C} \pm 5^{\circ}\text{C}$ baking not less than 6 hours (lamp beads must be split into particles)

东莞市欧思科光电科技有限公司

DONGGUAN OPSCO OPTOELECTRONICS CO., LTD

Factory : Lianxing industrial park, xiajie village, Qishi Town, Dongguan City. guangdong province, China

Dongguan Tel: (769)82632725

Dongguan Fax: (769)82632735

3.7. Reflow Soldering Characteristics

In testing, OPSCO has found S50 LEDs to be compatible with JEDEC J-STD-020E, using the parameters listed below. As a general guideline OPSCO recommends that users follow the recommended soldering profile provided by the manufacturer of solder paste used.

Note that this general guideline is offered as a starting point and may require adjustment for certain PCB designs and Configurations of reflow soldering equipment.

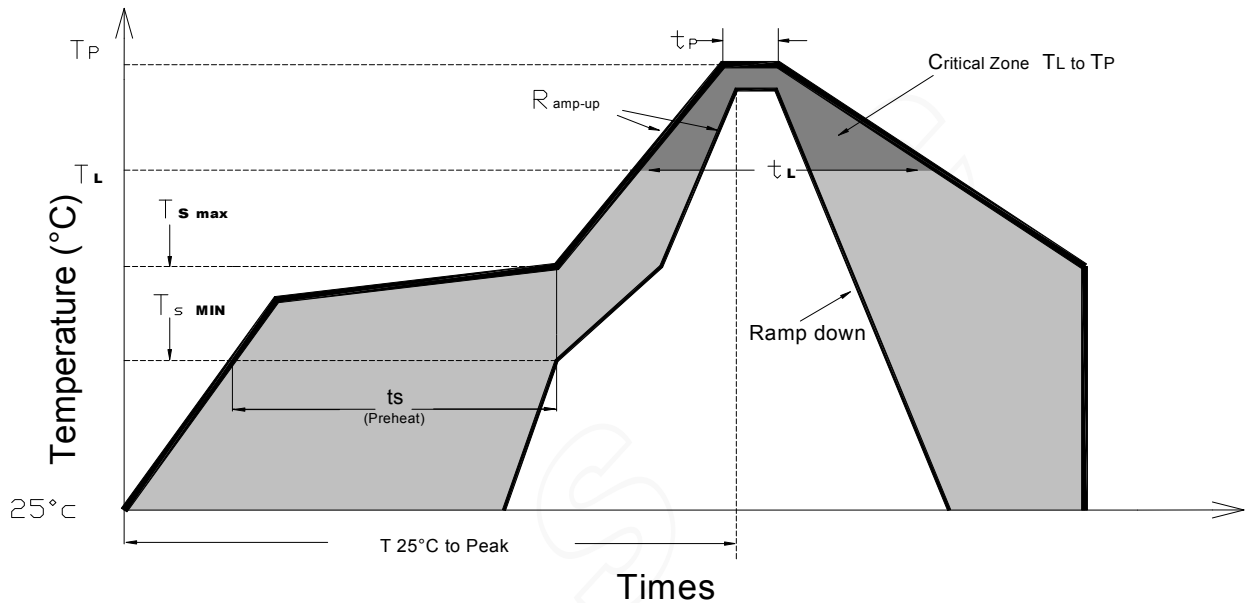

Profile Feature	Lead-Based Solder	Lead-Free Solder
Average Ramp-Up Rate ($T_s \text{ max}$ to T_p)	3°C/second max.	3°C/second max.
Preheat: Temperature Min ($T_s \text{ min}$)	100°C	150°C
Preheat: Temperature Min ($T_s \text{ max}$)	150°C	200°C
Preheat: Time ($t_s \text{ min}$ to $t_s \text{ max}$)	60-120 seconds	60-180 seconds
Time Maintained Above: Temperature (T_L)	183 °C	217 °C
Time Maintained Above: Time (t_L)	60-150 seconds	60-150 seconds
Peak/Classification Temperature (T_p)	215 °C	240 °C
Time Within 5°C of Actual Peak Temperature (t_p)	<10 seconds	<10 seconds
Ramp-Down Rate	6°C/second max.	6°C/second max.
Time 25 °C to Peak Temperature	<6 minutes max.	<6 minutes max.

Note: All temperatures refer to topside of the package, measured on the package body surface.

东莞市欧思科光电科技有限公司

DONGGUAN OPSCO OPTOELECTRONICS CO., LTD

Factory : Lianxing industrial park, xiajie village, Qishi Town, Dongguan City. guangdong province, China

Dongguan Tel: (769)82632725

Dongguan Fax: (769)82632735

3.8 General design requirements :

. SMT nozzle requirements: (red circle refers to the nozzle diameter)

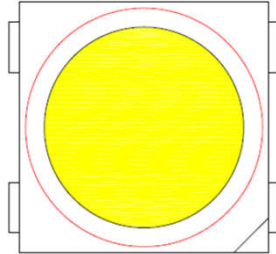

OK (nozzle diameter is greater than the light bulb area)

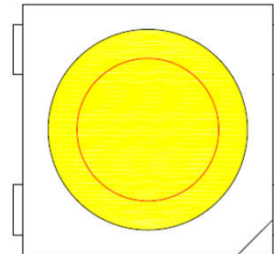

NG (nozzle diameter is less than the light beads light area)

- . Material to take way: with tweezers folder material, can not press the colloid or sharp objects to touch the colloid, the material can not be stacked;

a. Correct handling

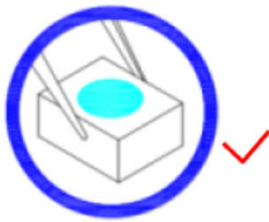

b. Wrong handling and wrong display after assembling

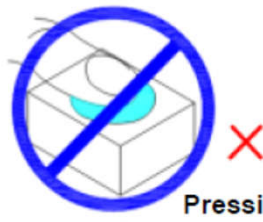

Pressing gels

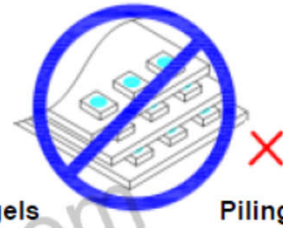

Piling up material

- . Products in the PCB layout design, for the soft sheet, and 0.5T below the plate, the pad direction should be perpendicular to the direction of PCB extension to reduce the PCB board bending stress generated in the LED pin, resulting in LED products Due to stress acting tensile failure;

3.9 Heat Generation:

Thermal design of the end product is of paramount importance. Please consider the heat generation of the LED when making the system design. The coefficient of temperature increase per input electric power is affected by the thermal resistance of the circuit board and density of LED placement on the board, as well as components. It is necessary to avoid in tense heat generation and operate within the maximum rating given in this specification. The operating current should be decided after considering the ambient maximum temperature of LEDs

The maximum working temperature of the product is not easy to exceed 40 ° C (≤ 40 ° C, refers to the product pin at the operating temperature)

东莞市欧思科光电科技有限公司

DONGGUAN OPSCO OPTOELECTRONICS CO., LTD

Factory : Lianxing industrial park, xiajie village, Qishi Town, Dongguan City. guangdong province, China

Dongguan Tel: (769)82632725

Dongguan Fax: (769)82632735

4.0 Electrostatic Discharge & Surge Current :

Electrostatic discharge (ESD) or surge current (EOS) may damage LED.

Precautions such as ESD wrist strap, ESD shoe strap or antistatic gloves must be worn whenever handling of LED.

IC device signal input and output ports must be connected in series protection resistor to prevent surge or static shock port caused by product failure;

All devices, equipment and machinery must be properly grounded.

It is recommended to perform electrical test to screen out ESD failures at final inspection.

It is important to eliminate the possibility of surge current during circuitry design.

4.1 Moisture Proof Package

Cannot take any responsibility for any trouble that are caused by using the LEDs at conditions exceeding our specifications.

The LED light output is strong enough to injure human eyes. Precautions must be taken to prevent looking directly at the LEDs with unaided eyes for more than a few seconds.

The formal specification must be exchanged and signed by both parties before large volume purchase begins.

The appearance and specifications of the product may be modified for improvement without notice.